

Specifications - Aqua Whisper Mini / Ultra Whisper * For general system specifications, refer to page 22

MODEL	Production / Hr.	Production / 24Hrs.	Weight
AQW MINI 170	7 gal / 27 liters	170 gal / 644 liters	70 lbs / 32 kg
AQW MINI 350	15 gal / 55 liters	350 gal / 1,325 liters	105 lbs / 48 kg

ELECTRICAL	Phase	Pump Motor	Voltage	Hz	H.P.	Normal Operating Amps	Start Up Current
AQW MINI 170		High Pressure / Booster	12 / 24VDC	N/A	.333	12 / 24VDC 29 / 14	12 / 24VDC 120 / 60
	Single	High Pressure / Booster	110 / 230	50 / 60	.333	110 / 230 6 / 3	110 / 230 26 / 13
AQW MINI 350	Single	High Pressure / Booster	110 / 230	50 / 60	1	110 / 230 13 / 6.5	110 / 230 52 / 26

Circuit breaker Size	Operating AC Voltage	Phase	Recommended circuit breaker
AQW MINI 170	12 / 24VDC	Single	40 Ampere / 20 Ampere
	110 / 230		12 Ampere / 10 Ampere
AQW MINI 350	110 / 230	Single	20 Ampere / 15 Ampere

SYSTEM	Model #	Production / Hr.	Weight - Compact	Weight - Modular	ELECTRICAL	Feed Pump and Motor	VAC	NOA	SUC
ULTRA WHISPER	200	8 gal / 32 liters	130 lbs / 59 kg	125 lbs / 59 kg	ULTRA WHISPER 200	12V DC		13.0	95
	300	13 gal / 47 liters	145 lbs / 66 kg	140 lbs / 63 kg		24V DC		7.0	48
	400	17 gal / 63 liters	145 lbs / 66 kg	140 lbs / 63 kg	ULTRA WHISPER 300 / 400	Phase HZ			
	500	21 gal / 79 liters	155 lbs / 70 kg	150 lbs / 68 kg		Single 50 / 60	115	5.1 / 4.4	15
	600	25 gal / 95 liters	155 lbs / 70 kg	150 lbs / 68 kg		Single 50 / 60	230	2.5 / 2.2	8
					ULTRA WHISPER 500 / 600	12V DC		22.0	95
						24V DC		11.0	48
						Phase Hz			
						Single 50 / 60	115	6.7 / 5.8	15
						Single 50 / 60	230	3.3 / 2.9	8
						24V DC		22.0	60
						Phase Hz			
						Single 50 / 60	115	11.3 / 9.8	33
						Single 50 / 60	230	5.6 / 4.9	15

H.P. = Horse Power • NOA = Normal Operating Amps • SUC = Start Up Current

Dimensions

AquaWhisper MINI

COMPACT 170

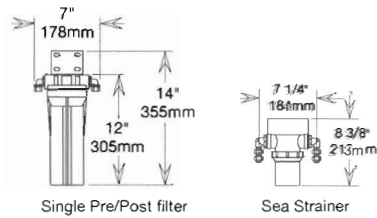
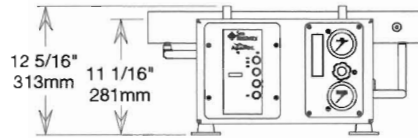

COMPACT 350

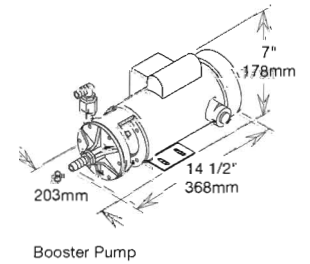
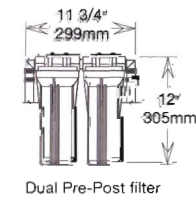
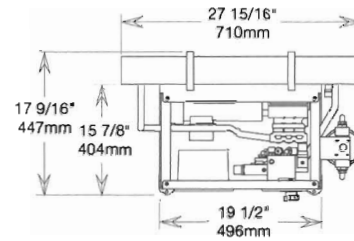
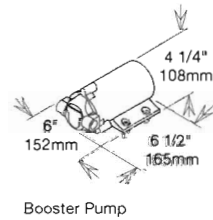
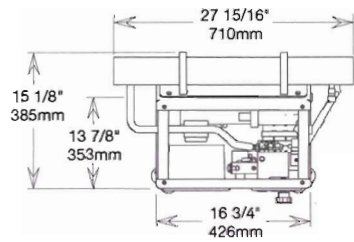
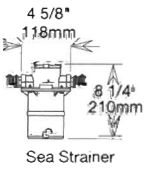
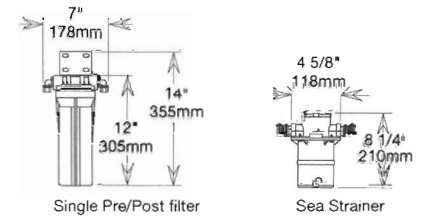
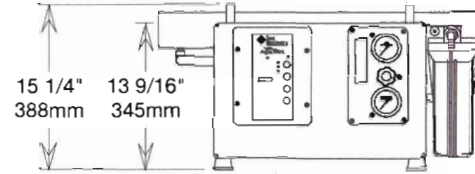

UltraWhisper™

COMPACT

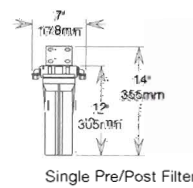
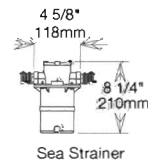
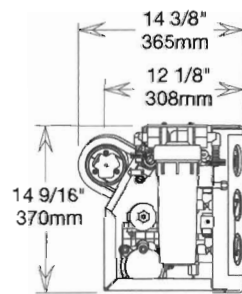
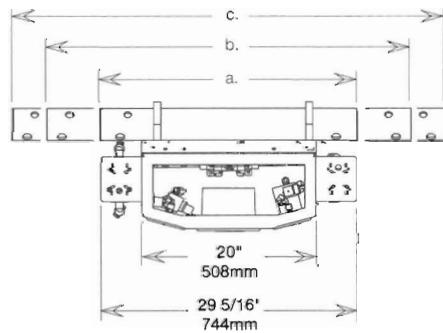

MODULAR

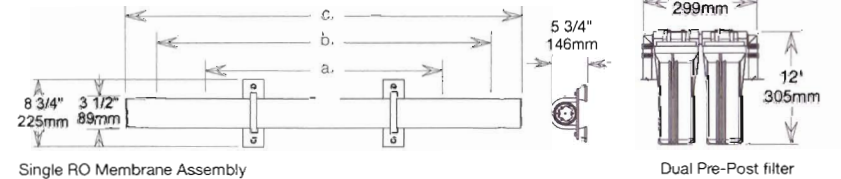
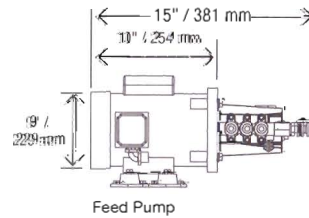
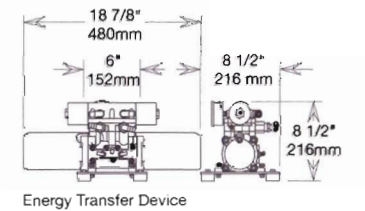
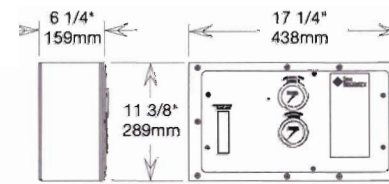

- a. 27 15/16" - 710mm: SRC Ultra Whisper Compact / Modular 200
- b. 37 15/16" - 964mm: SRC Ultra Whisper Compact / Modular 300
- c. 46 15/16" - 1192mm: SRC Ultra Whisper Compact / Modular 400, 500 & 600

WATER CONNECTIONS: Feed Water 1/2" Brine Discharge 1/2" Product Water 1/4"